

WV



WALDORF ASTORIA®
RESIDENCES · MIAMI

A journey in transcendence.

Much like the thriving metropolis within which it sits, Waldorf Astoria Residences Miami offers an experience in transcendence - an exclusive lifestyle offering embedded within a legacy brand that has stood the test of time.

Residents here will not only assume a coveted place in a landmark building's history, but also as part of a cutting-edge community of culture shapers, intrinsically playing a role in boldly defining societal moments.

Waldorf Astoria Residences Miami, with its limitless views, extraordinary architecture and timeless brand, will usher in a new era for generations to come.



History / 08
Global Brand / 12
Architecture / 16
Amenities / 26
Residences / 44
Location / 78
Team / 86

Timeless moments. Modern masterpiece.

Waldorf Astoria Residences Miami builds on a legacy of elegance, style, and service, with a transcending vision true to its history, yet reflective of the now.



Where our
story began.

Waldorf Astoria History

Since opening its first landmark hotel in New York City over a century ago, Waldorf Astoria has become synonymous with luxury hospitality and exceptional service. The hotel redefined hospitality excellence through the invention of 24-hour room service, daring culinary innovations, and attracting culture-shaping clientele. Waldorf Astoria continues to be known for its intuitive tenacity to transform any moment, from the grand to the routine, into something unforgettable.

Waldorf Astoria's roots have spread across the globe, and we are now a portfolio of over 30 hotels in iconic destinations. The brand carries the same pioneering mantle and remains a beacon of timeless glamour and sophistication.

Waldorf Astoria's iconic legacy is guided by an evolved sense of transformation, and like all true leaders, a bold vision for what is to come.





Built on a foundation of excellence.

The world-renowned elegant service is curated with a sense of care, authenticity, and thoughtful precision for a personalized living experience like no other.

Through luxurious environments, Waldorf Astoria creates exceptional experiences that become lasting memories for our residents.

Waldorf Astoria Maldives Ithaafushi



Waldorf Astoria Amsterdam

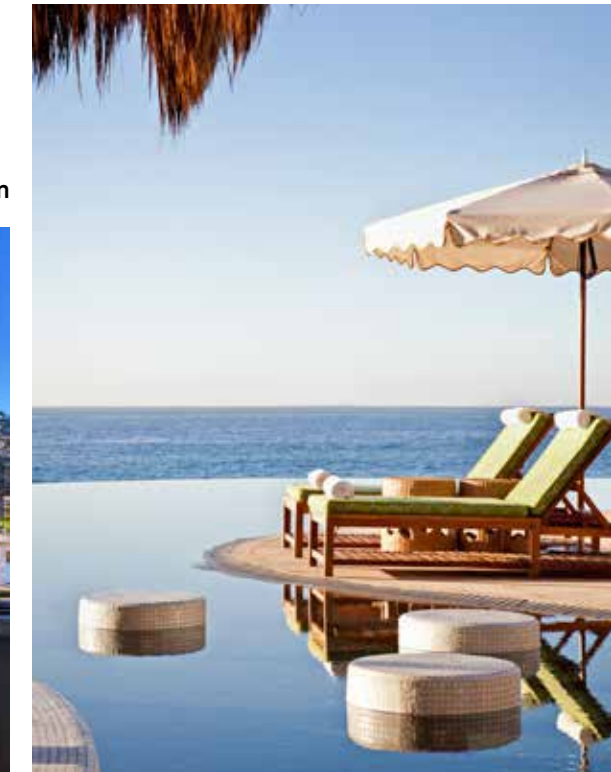

Waldorf Astoria Los Cabos Pedregal

Offering exceptional experiences at one of the world's most legendary hotel brands, each Waldorf Astoria represents a unique personality with undeniable global presence and relevance.



Waldorf Astoria Shanghai on the Bund

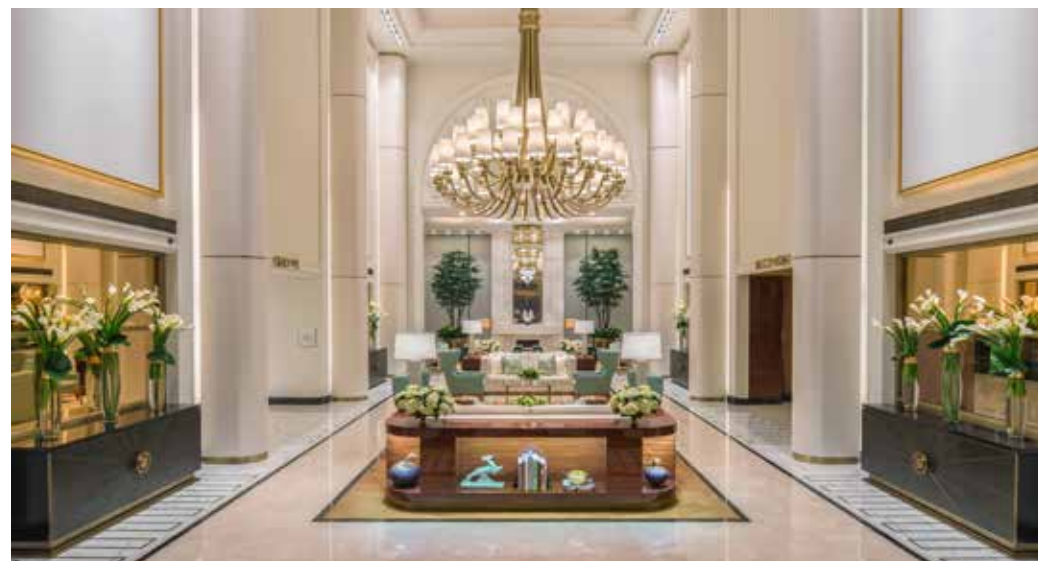

Waldorf Astoria Beverly Hills



Waldorf Astoria Bangkok

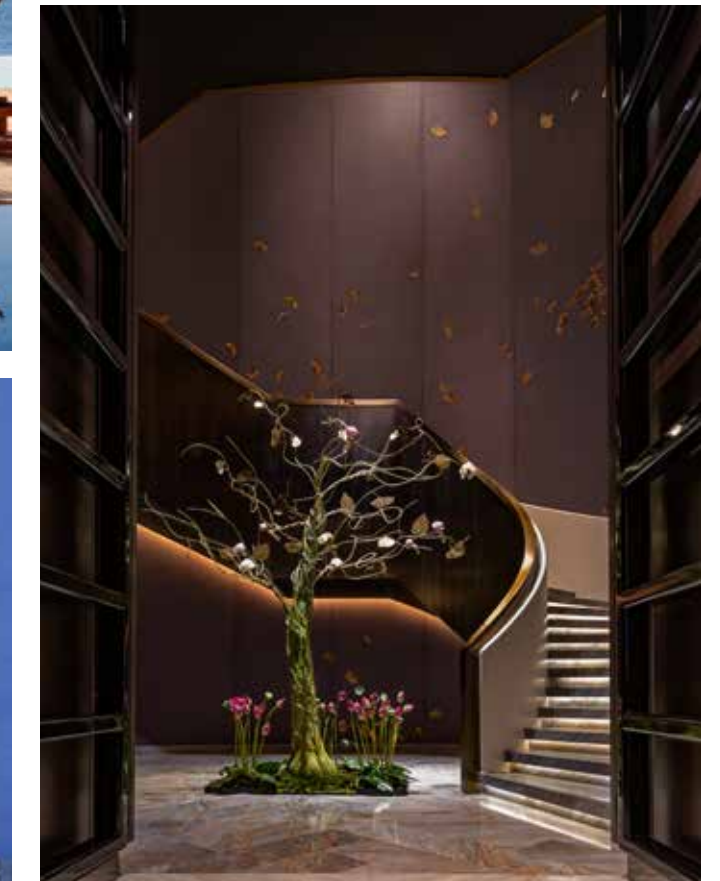

Waldorf Astoria Beijing



Unveiling of a modern masterpiece.

Designed conceptually by Carlos Ott and the architectural firm Seiger Suarez, Waldorf Astoria Residences Miami will be the landmark beacon of this global city. Located in Downtown Miami, the towering structure is an experience in exclusivity. Here, life is designed for those who appreciate one-of-a-kind, enrichment that inspires.



“The form
is always
the measure
of the
obsession.”



Standing Woman
1958

Alberto Giacometti

Inspired by 20th Century sculptor Alberto Giacometti, who explored themes of space, perspective and fractured forms, the building's cubism-influenced design stands prominently as the city's tallest structure; an architectural phenomenon and a defining symbolic moment in Miami's ascendance.



Carlos Ott
CONCEPTUAL ARTIST



With more than a half century of combined design experience, our design collective consists of the conceptual genius of Carlos Ott and the distinguished residential design experience of Sieger Suarez Architects. The result is in an unparalleled powerhouse of talent to exceed expectations for what is to be the tallest and most notable building on the east coast of the country, south of the Manhattan skyline.



Sieger Suarez
ARCHITECTURAL PARTNERSHIP

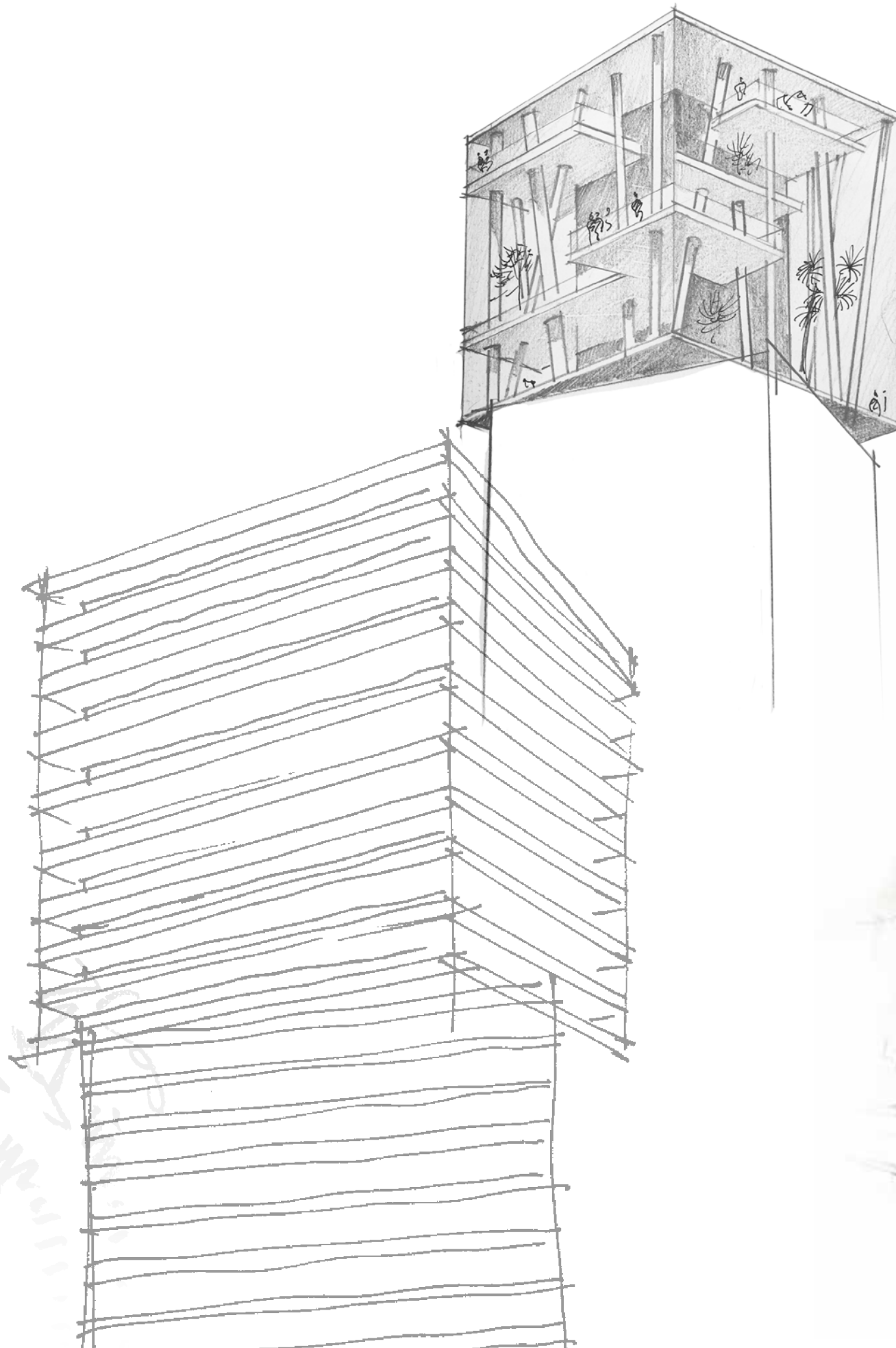
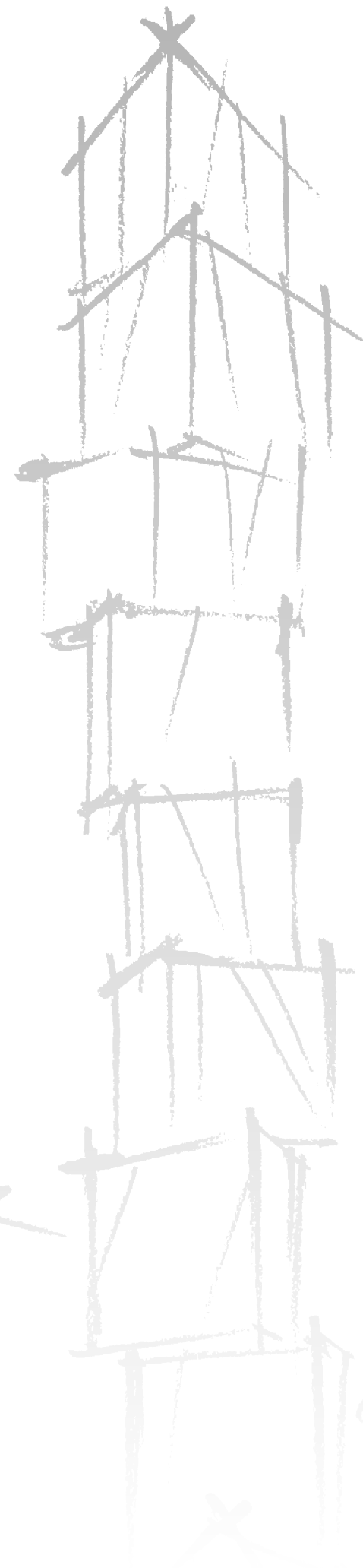
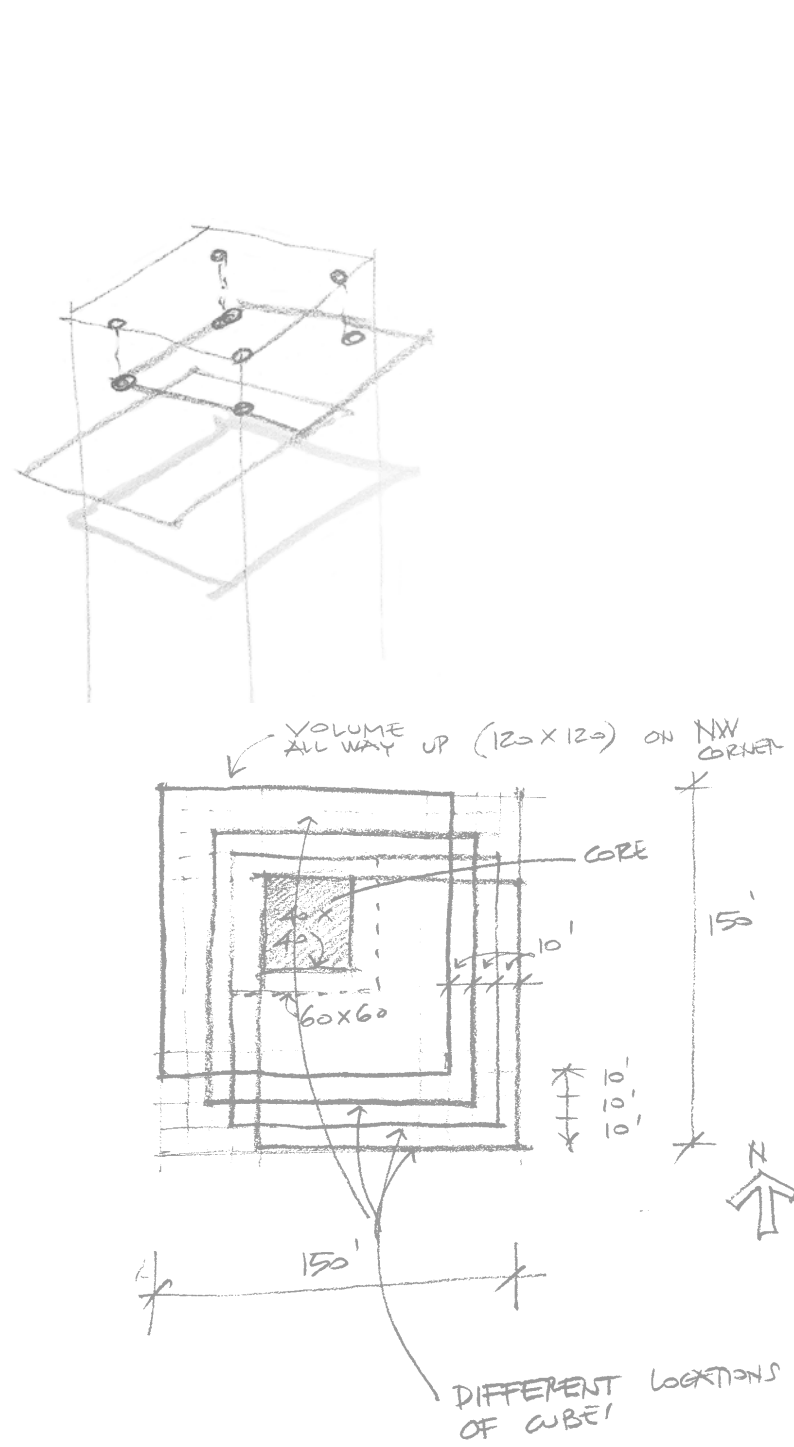

Downtown Miami





Ascendance begins upon arrival.

A transformative experience begins as early as one's arrival at the opulent porte cochère. A sense of awe and intrigue abounds as we first encounter the attentive service synonymous with the Waldorf Astoria name. Ascendance into a new realm continues upon entrance as the magnificent, open air lobby with its dramatic, curved, glass enclosed 4-story staircase introduces us to a visionary building, with an even more visionary experience to be had.

YOU HAVE ARRIVED.

Moments in arrival continue as we are welcomed by the third level residential lobby with its sky-high ceilings and panoramic bay views. Home to the residential concierge and private amenities, it's here where greetings are exchanged, welcomes are extended and residents commingle in residential spaces.



Residential Lobby

Owners Lounge





To see and be seen.

Unobstructed views of the ocean and the downtown Miami skyline provide the perfect backdrop for the awe-inspiring Peacock Alley, centered around the larger than life signature Pendulum Clock, a tradition for every Waldorf Astoria property. Inspired by the original Foucault Pendulum, invented in 1851, now famously hanging from the dome of the Pantheon in Paris, this structure remains fixed while illustrating time and the rotation of the earth, reminding us of both the pure beauty and suspended timelessness of our current surroundings.

Peacock Alley





Assume a seat in an updated rendition of the historic Peacock Alley, a venue renowned for its extravagant Sunday brunch and innovative cocktail culture. Or sip serenely while sitting at the elegant private bar and wine tasting room while simply soaking in the aura and energy flow of the surroundings, asymmetrical in design yet anchored with a carefully studied sense of logic and placement. A place where each moment is to be cherished.





Authentic moments abound.

Beyond world-renowned food and beverage offerings, residents enjoy exclusive hotel benefits, including house account signing privileges and preferred access to the spa and other hotel venues.



Mindfulness and moments of authenticity never end with access to the signature spa and fitness center which features opulently designed wellness lounges, saunas, steam and treatment rooms as well as personalized health, nutrition and fitness programs. Residents will regularly find themselves pampered with the ultimate in healing, relaxation, rejuvenation and an experience in self-care.

EXPERIENCE SIGNATURE SPACES.

Waldorf Astoria is known for providing unforgettable moments in landmark destinations worldwide. Conceptually designed by Sieger Suarez Architects and Carlos Ott, in collaboration with interior design firm BAMO, these award-winning designers worked in tandem to create this iconic structure in Downtown Miami. Rising 1,049 feet above Biscayne Bay, the striking tower will be the tallest residential tower south of Manhattan, offering breathtaking views and signature experiences.

Building Features

- 100-story tower located in Downtown Miami
- Unobstructed views of downtown, Miami Beach and Atlantic Ocean
- 360 branded luxury residences
- Hotel guestrooms and suites available
- Peacock Alley
- Immersive resort pool with outdoor café and private cabanas
- Private Bar / Wine Tasting Room
- Signature Restaurant
- All-Day Dining Brasserie
- Meeting venue offering spaces from ballrooms to boardrooms
- Kids Club



A home above all else.

Waldorf Astoria Residences Miami is where high concept design intersects with the utmost in convenience, technology and beauty down to the most minute detail. The living space is designed for upward energy flow, and refined with tailored details by the award-winning BAMO interior design firm. Live life as one with breathtaking backdrops of the downtown Miami skyline, Miami Beach and the Atlantic Ocean. Let your frame of mind be uplifted all while knowing the place you now call home is an experience in transcendence truly unrivaled anywhere else in the city.



RESIDENCES THAT INSPIRE.

Everyday life at Waldorf Astoria is filled with timeless moments to be shared through generations. Residents will be welcomed home to much more than elegant spaces, but a true sense of elevated experiences and authenticity.

Residence Features

- Fully-finished and furnished Junior Suites
- Fully-finished 1, 2, 3, and 4-bedroom private residences
- All residential interiors are designed by award-winning interior design firm BAMO
- 10-foot floor-to-ceiling windows with stunning views of city and downtown skyline, Miami Beach and Atlantic Ocean
- Smart home technology experience for seamless personalization with the touch of a button. Includes integrated audio, video and lighting systems
- Contemporary lighting package, including recessed lighting, dimmers, and lighting control
- Custom built-out closets in all residences and flooring selections curated by BAMO
- Built in top-of-the-line washer and dryer
- Pre-wired for high-speed communications

East View • 100 Stories







South View • 100 Stories





FOR YOUR SENSES.

The utmost in consideration is weaved naturally into every corner of the home from kitchens to bathrooms. Experience the ultimate from kitchen design mastery to a virtual palace for self-care with fixtures, features and accessories created with true refinement in mind.

Kitchen and Baths

- Kitchens feature custom cabinetry curated by BAMO and fabricated by Italian design house Italkraft
- Sub-Zero and Wolf appliance package includes integrated paneled microwave, dishwasher, built-in convection oven, refrigerator, freezer and wine storage
- Select primary and secondary bathrooms offer rain showers and custom Italian vanities
- Dornbracht and Duravit bathroom fixtures







Northeast View • 100 Stories



PRIVATE RESIDENTIAL SERVICES AND AMENITIES.

The celebrated Waldorf Astoria services and amenities have been reimagined for today's modern living. Everything naturally and intuitively has been curated for our resident's convenience.

- Savant premium smart-home tech systems are designed to provide residents with a touch-screen monitor and iPad access to concierge services using a custom app accessible to a full menu of available offerings including:
 - 24-hour doormen and lobby desk attendants
 - Private porte cochère with 24-hour valet service and private residential entry
 - 24-hour concierge services in addition to dedicated on-site professionals
 - Owners Lounge with double height ceilings, billiard and entertainment room with panoramic bay views, designed for private functions and equipped with adjacent catering kitchen
 - Private residential pool deck with whirlpools and lounging areas
 - Exclusive Waldorf Astoria Miami access and benefits, including preferred spa and restaurant rates and access to à la carte hotel services
 - Valet parking included

- Residents will also have access to concierge services using a custom app accessible to a full menu of available offerings including:
 - 24/7 room service
 - Spa and fitness treatments
 - House car reservations
 - Valet service access
 - Package delivery service



West View • 100 Stories





A modern global city.

Miami has rapidly evolved into a world-class city and downtown Miami has become a true driving force behind the city's cultural evolution. From its accessibility to the retail and tourism offerings, this thriving metro center is a hub for commerce, finance, arts, sports and entertainment. The building itself pays homage to the architecture of the city with understated references to its art-deco history, commissioned artworks that will line the interior and a nod to Miami's intrinsic curves and textures.

Live life at the epicenter of a town where the international influences between art, culture and natural beauty collide in a one-of-a-kind way at an equally powerful moment in this city's history.



Downtown Miami



Pérez Art Museum Miami

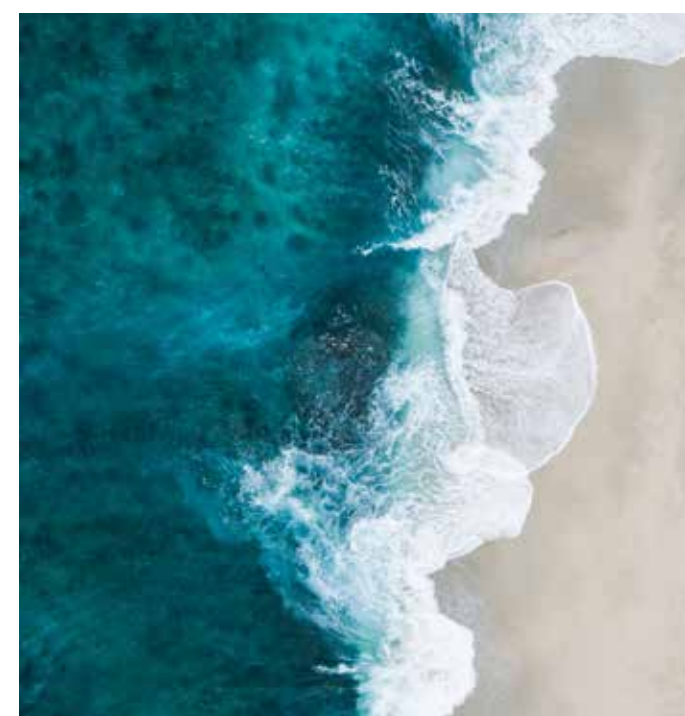

Miami Beach



Miami Design District



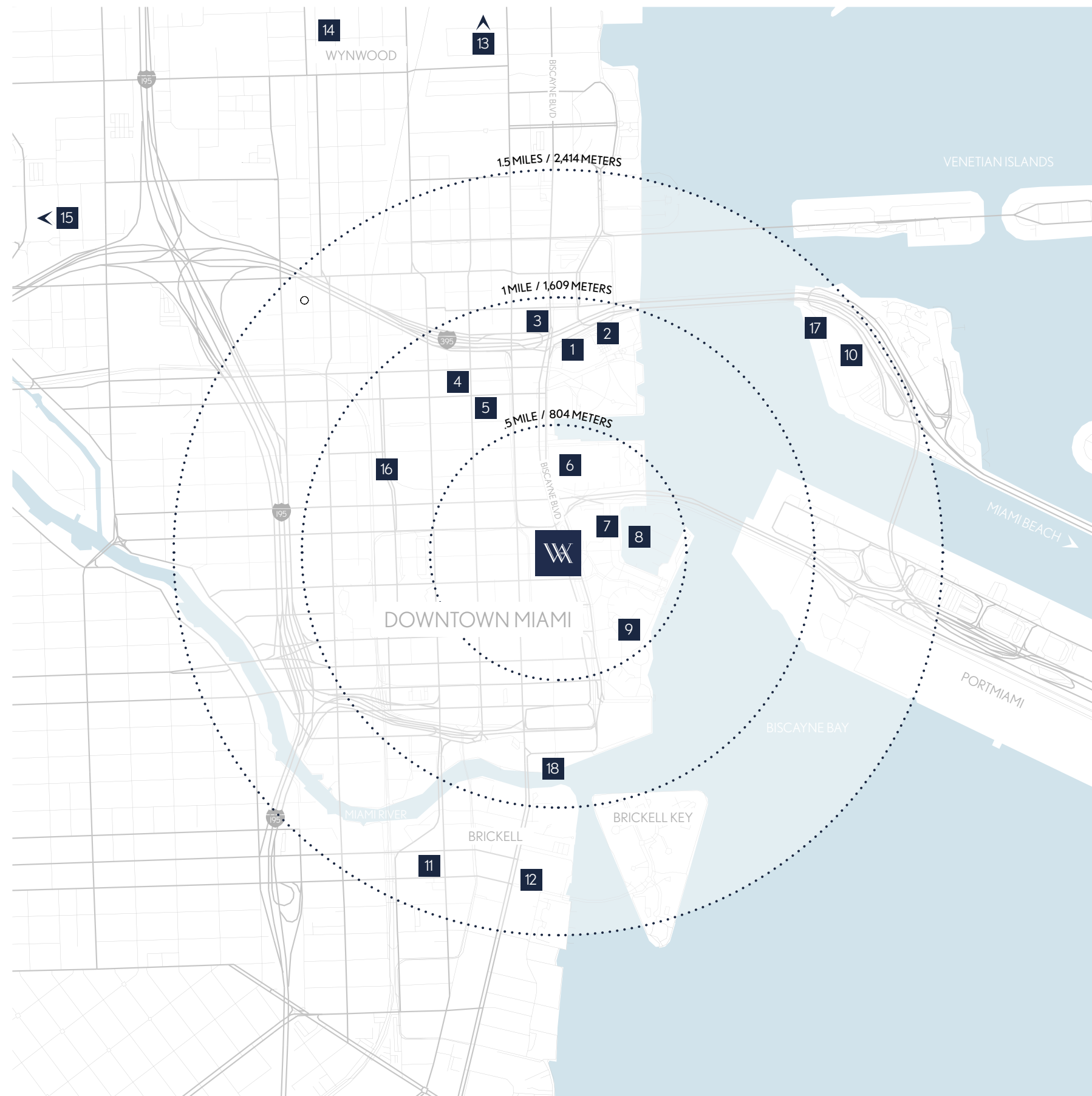

CENTRAL YET GLOBAL.

The legendary Waldorf Astoria Miami is situated within an environment of creative entities, culinary delights and inspired venues. All of which are examples of enormous aspirations fully achieved and realized. Its unveiling will represent the foundation for the future of Miami.

Nearby attractions include:

- 1 Phillip & Patricia Frost Museum of Science
- 2 Pérez Art Museum Miami (PAMM)
- 3 The Adrienne Arsht Center for the Performing Arts
- 4 Park West District
- 5 Miami Worldcenter
- 6 American Airlines Arena
- 7 Bayside Marketplace
- 8 Miamarina at Bayside
- 9 Bayfront Park
- 10 Miami Children's Museum
- 11 Brickell City Centre
- 12 Brickell Financial District
- 13 Miami Design District
- 14 Wynwood Art District
- 15 Miami International Airport
- 16 MiamiCentral Station - Brightline Trains
- 17 Yacht Haven Grande Miami at Island Gardens
- 18 Miami River District

An assemblance of passions.

Waldorf Astoria Residences Miami reflects the intersection of an extraordinary team all collaborating to bring a modern expression of Waldorf Astoria's rich legacy to life.

DEVELOPERS



Founded in 1991 by Kevin Maloney, Property Markets Group (“PMG”) has direct hands-on experience in the acquisition, renovation, financing, operation, and marketing of commercial and residential real estate. A development firm of national scope, PMG has over 150 real estate transactions including over 80 residential buildings in Manhattan during its 25-year history. PMG has distinguished itself over the last decade for its development of new construction condominium developments in New York City, Miami and Chicago.



Greybrook Realty Partners is a Toronto-based private equity firm that invests in large-scale real estate development and value-add assets. Over the years, Greybrook has built a strong reputation for its ability to create value for its investors, partners and communities.

Ranging from single-family homes, condominiums and purpose-built rental, to ultra-luxury condominium residences and retail, Greybrook’s diversified real estate portfolio includes investments in more than 85 projects that represent over 43 million square feet of residential and commercial density in aggregate, with an estimated completion value of \$19 billion.



With almost two decades of condominium development experience and more than 600 luxury waterfront residences delivered in South Florida alone, S2 Development principals, J. Claudio Stivelman and Marc D. Schmulian have worked with many of the world’s most notable architects and designers to produce spectacular landmark developments. With luxury residential projects ranging from Bay Harbor Islands to Sunny Isles Beach, S2 maintains their reputation as leaders in luxury real estate development by building with a meticulous and detail-oriented approach in South Florida’s most desirable areas.

DEVELOPERS



Mohari Hospitality, founded in 2017 by entrepreneurial investor Mark Scheinberg, is a global investment company with emphasis on luxury hospitality in prime urban and resort markets. Mohari’s investments include equity and debt in both development and operating assets and Mohari invests both independently and with partners. Mohari’s existing investments include Peninsula Papagayo, a 2,200-acre sustainable hotel and residential development in Costa Rica; The Ritz-Carlton Yacht Collection, a new ultra-luxury cruise line, the 1 Hotel in Toronto and the Four Seasons Hotel in Madrid. Mohari seeks to protect the cultural heritage and natural environments of all areas related to its projects and is committed to identifying and contributing to philanthropic projects in each location where it does business.

ARCHITECTS

sieger suarez

CONCEPTUAL ARTIST / ARCHITECT OF RECORD

Sieger Suarez Architects is a distinguished leader of luxury high-rise residential design and development. Premier front-runners in the Southeastern United States, Sieger Suarez have been producing buildings of prominence and a legacy of excellence for four decades.

With masterpieces which range among the most prestigious residential buildings in South Florida, innovative design along with the use of groundbreaking technology have set Sieger Suarez apart, and raised expectations within luxury residential development.

CARLOS OTT

CONCEPTUAL ARTIST

With more than 40 years of unparalleled design and architectural experience, Carlos Ott has been hailed as one of the best conceptual minds of his generation. A recipient of a Fulbright scholarship and a winner of numerous competitions as well as architectural prizes, Ott is a prodigy. Globally recognized, his signature designs can be found throughout France, Germany, China, Singapore, Dubai and more.

INTERIOR ARCHITECTURE
& DESIGN

INTERIOR DESIGN FIRM

We are BAMO. For thirty years, we've created captivating environments that flow, function, and make people feel welcome, at ease, and inspired to live – and to dream – more fully.

A collective of designers, we bring to each project a richness of experience and perspective, along with an impassioned view of life and our work.

We engage clients graciously, listening for the unspoken needs beneath their stated desires. Speaking to the psyche through the senses, and building in layers of meaning, we create true havens: places apart from the everyday. Our interpretive skill is matched by the rigor, expertise, and ingenuity we bring to seeing projects through to completion. This is why hospitality, residential, and corporate clients around the world trust us to bring their visions to life.

PROPERTY MANAGEMENT



Waldorf Astoria Hotels & Resorts is a portfolio of more than 30 iconic properties that creates a unique sense of place with a relentless commitment to personal service and culinary expertise in landmark locations around the world. Unified by their inspirational environments and True Waldorf Service, Waldorf Astoria hotels deliver graceful service from the moment a guest books through checkout. In addition to the brand's renowned hotel offerings, Waldorf Astoria boasts a best-in-class residential portfolio, including 17 properties either open or in development, that provide the comfort of a private home combined with the unsurpassed amenities and legendary service of Waldorf Astoria. Waldorf Astoria is a part of Hilton, a leading global hospitality company.



WALDORF ASTORIA®
RESIDENCES · MIAMI

waldorfresidencesmiami.com

WALDORF ASTORIA IS A REGISTERED TRADEMARK OF HILTON INTERNATIONAL HOLDING LLC, AN AFFILIATE OF HILTON WORLDWIDE HOLDINGS INC. ("HILTON"). THE RESIDENCES ARE NOT OWNED, DEVELOPED, OR SOLD BY HILTON AND HILTON DOES NOT MAKE ANY REPRESENTATIONS, WARRANTIES OR GUARANTIES WHATSOEVER WITH RESPECT TO THE RESIDENCES. THE DEVELOPER USES THE WALDORF ASTORIA BRAND NAME AND CERTAIN WALDORF ASTORIA TRADEMARKS (THE "TRADEMARKS") UNDER A LIMITED AND NONEXCLUSIVE LICENSE FROM HILTON. THE LICENSE MAY BE TERMINATED OR MAY EXPIRE WITHOUT RENEWAL, IN WHICH CASE THE RESIDENCES WILL NOT BE IDENTIFIED AS A WALDORF ASTORIA BRANDED PROJECT OR HAVE ANY RIGHTS TO USE THE TRADEMARKS.

ⓘ NO FEDERAL AGENCY HAS JUDGED THE MERITS OR VALUE, IF ANY, OF THIS PROPERTY. THIS IS NOT AN OFFER TO SELL, OR SOLICITATION OF OFFERS TO BUY, THE CONDOMINIUM UNITS IN STATES WHERE SUCH OFFER OR SOLICITATION CANNOT BE MADE. THESE DRAWINGS ARE CONCEPTUAL ONLY AND ARE FOR THE CONVENIENCE OF REFERENCE. THEY SHOULD NOT BE RELIED UPON AS REPRESENTATIONS, EXPRESS OR IMPLIED, OF THE FINAL DETAIL OF THE RESIDENCES. UNITS SHOWN ARE EXAMPLES OF UNIT TYPES AND MAY NOT DEPICT ACTUAL UNITS. STATED SQUARE FOOTAGES ARE RANGES FOR A PARTICULAR UNIT TYPE AND ARE MEASURED TO THE EXTERIOR BOUNDARIES OF THE EXTERIOR WALLS AND THE CENTERLINE OF INTERIOR DEMISING WALLS AND IN FACT ARE LARGER THAN THE AREA THAT WOULD BE DETERMINED BY USING THE DESCRIPTION AND DEFINITION OF THE "UNIT" SET FORTH IN THE DECLARATION OF CONDOMINIUM (WHICH GENERALLY ONLY INCLUDES THE INTERIOR AIRSPACE BETWEEN THE PERIMETER WALLS AND EXCLUDES INTERIOR STRUCTURAL COMPONENTS). THE AREA OF THE UNIT AS DEFINED IN THE DECLARATION IS LESS THAN THE SQUARE FOOTAGE REFLECTED HERE. ALL DEPICTIONS OF APPLIANCES, PLUMBING FIXTURES, EQUIPMENT, COUNTERS, SOFFITS, FLOOR COVERINGS AND OTHER MATTERS OF DETAIL ARE CONCEPTUAL ONLY AND ARE NOT NECESSARILY INCLUDED IN EACH UNIT. THE FURNISHINGS AND DÉCOR ILLUSTRATED OR DEPICTED ARE NOT INCLUDED WITH THE PURCHASE OF THE UNIT. CONSULT YOUR PURCHASE AGREEMENT AND ANY ADDENDA THERETO FOR THE ITEMS INCLUDED WITH THE UNIT. DIMENSIONS AND SQUARE FOOTAGE ARE APPROXIMATE, WILL VARY WITH SPECIFIC UNIT TYPE AND MAY VARY WITH ACTUAL CONSTRUCTION. ADDITIONALLY, MEASUREMENTS OF ROOMS SET FORTH ON ANY FLOOR PLAN ARE NOMINAL AND GENERALLY TAKEN AT THE GREATEST POINTS OF EACH GIVEN ROOM (AS IF THE ROOM WERE A PERFECT RECTANGLE), WITHOUT REGARD FOR ANY CUTOUTS. UNIT ORIENTATION AND WINDOWS (INCLUDING NUMBER, SIZE, ORIENTATION AND AWNINGS), BALCONY/LANAIS (INCLUDING CONFIGURATION, SIZE AND RAILING/BALUSTRADE), STRUCTURE AND MECHANICAL CHASES MAY VARY. THE DEVELOPER EXPRESSLY RESERVES THE RIGHT TO MAKE MODIFICATIONS, REVISIONS AND CHANGES IT DEEMS DESIRABLE IN ITS SOLE AND ABSOLUTE DISCRETION AND WITHOUT NOTICE. ALL DRAWINGS ARE CONCEPTUAL RENDERINGS AND THE DEVELOPER EXPRESSLY RESERVES THE RIGHT TO MAKE MODIFICATIONS. ACTUAL VIEWS MAY VARY AND CANNOT BE GUARANTEED. VIEWS SHOWN CANNOT BE RELIED UPON AS THE ACTUAL VIEW FROM ANY PARTICULAR UNIT WITHIN THE CONDOMINIUM. IMPROVEMENTS, LANDSCAPING AND AMENITIES DEPICTED MAY NOT EXIST. PRICES, PLANS, ARCHITECTURAL INTERPRETATIONS AND SPECIFICATIONS ARE SUBJECT TO CHANGE WITHOUT NOTICE. THE INFORMATION PRESENTED WITHIN THIS DOCUMENT IS CONCEPTUAL. THE IMAGES AND FEATURES CONTAINED HEREIN ARE NOT TO BE RELIED UPON OR USED AS A REFERENCE FOR SPECIFICATIONS. THE FOREGOING MATTERS ARE FURTHER ADDRESSED IN THE PURCHASE AGREEMENT AND ANY ADDENDA THERETO AND THE CONDOMINIUM DOCUMENTS.

waldorfresidencesmiami.com